

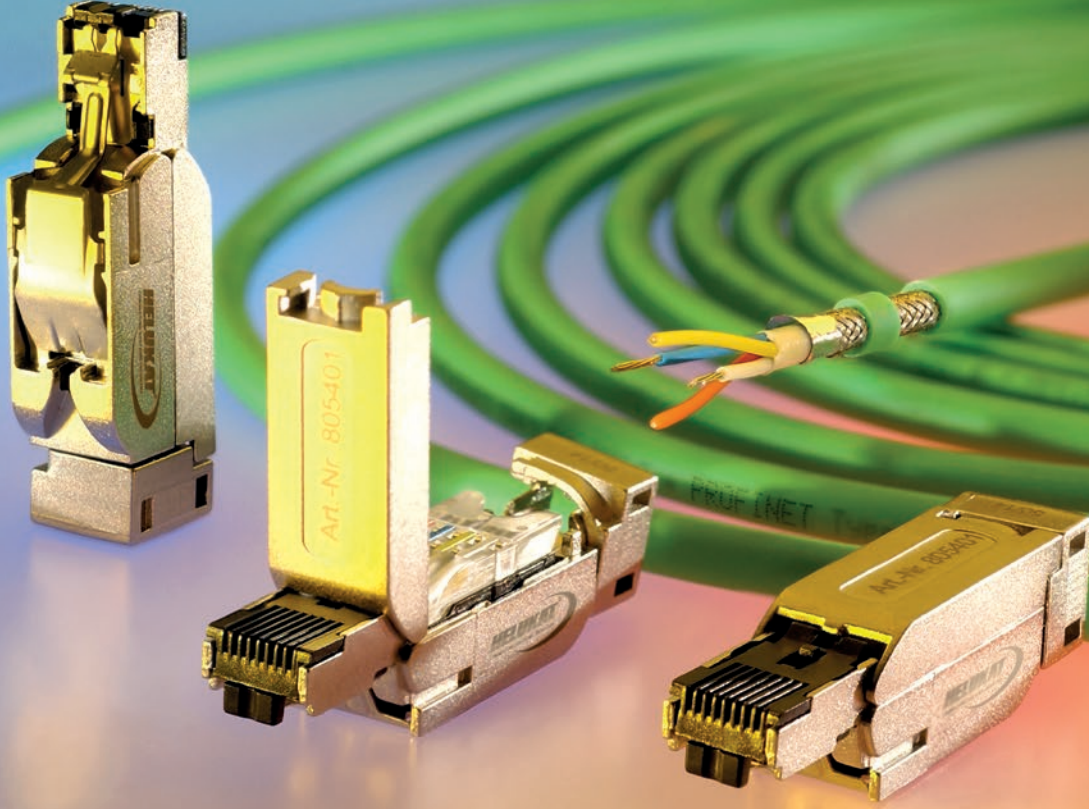

HELUKABEL®

**HELUKABEL İLE
HER ŞEY TEK ELDEN !**



Veri, Ağ ve Bus teknolojisi

Endüstriyel Ethernet

Kablolar • Konnektörler • Sonlandırılmış kablolar • Aletler



CC-Link



EtherCAT®

IND. ETHERNET

Tip	Uygulama	Kategori	Ürün No.	UL	Damar Ø	Kılıf Ø
Profinet A 2x2xAWG22/1 PVC	standart - sabit	Kat5	800653	CMG PLTC AWM 600V	1,5 mm	6,5 mm
Profinet A 2x2xAWG22/1 FRNC	halojensiz - sabit		805653	CMG PLTC AWM 600V		
Profinet A 2x2xAWG22/1 PUR	sağlam - sabit		801194	mevcut değil		
Profinet A 2x2xAWG22/1 PUR	işinlara karşı dayanıklı - sabit		801195	mevcut değil		
Profinet A 2x2xAWG22/1 PVC/PE	çelik zırlı - dış ortam - sabit		801650	mevcut değil		
Profinet B 2x2xAWG22/7 PVC	standart - esnek		800654	CMG PLTC AWM 600V	1,5 mm	6,5 mm
Profinet B 2x2xAWG22/7 FRNC	halojensiz - esnek		805654	CMG PLTC AWM 600V		
Profinet B 2x2xAWG22/7 FRNC	gemi yapımı - esnek		802185	CMG PLTC		
Profinet B 2x2xAWG22/7 PVC	Festoon - esnek		803295	CMG PLTC AWM 600V		
Profinet B 2x2xAWG22/7 X-FRNC	rüzgar enerjisi - esnek		802293	AWM 300V		
Profinet B Hybrid 2x2xAWG22/7+4x1,5 FRNC	halojensiz - esnek		801651	AWM 150V		
Profinet C 2x2xAWG22/7 PVC	hareketli kablo kanalı		802914	CMG PLTC AWM 600V		
Profinet C 2x2xAWG22/7 PUR	hareketli kablo kanalı		800655	CMX		
Profinet C 2x2xAWG22/19 PUR	Robotik		802186	AWM 150V		
Endüstriyel Ethernet 2x2xAWG24/1 FRNC	halojensiz - sabit	Kat5	805699	mevcut değil		
Endüstriyel Ethernet 2x2xAWG24/1 PUR	sağlam - sabit		805700	mevcut değil	1,0 mm	5,6 mm
Endüstriyel Ethernet 2x2xAWG26/7 FRNC	halojensiz - esnek		805701	mevcut değil	1,0 mm	5,6 mm
Endüstriyel Ethernet 2x2xAWG26/7 PUR	PUR - esnek		805702	AWM 1000V	1,0 mm	5,7 mm
Endüstriyel Ethernet 4x2xAWG26/7 PUR	sağlam - esnek		800068	mevcut değil	1,0 mm	5,8 mm
Endüstriyel Ethernet 4x1xAWG26/19 PUR	hareketli kablo kanalı Eco		82838	AWM 30V	1,0 mm	4,8 mm
Endüstriyel Ethernet 4x2xAWG26/19 PUR	hareketli kablo kanalı Eco		82839	AWM 30V	1,0 mm	6,6 mm
Endüstriyel Ethernet 4x1xAWG24/19 PUR	hareketli kablo kanalı		800088	mevcut değil	1,25 mm	6,2 mm
Endüstriyel Ethernet 4x2xAWG24/19 PUR	hareketli kablo kanalı		81155	mevcut değil	1,25 mm	9,5 mm
Endüstriyel Ethernet 4x2xAWG26/19 PUR	Robotik		800067	AWM 30V	1,0 mm	7,5 mm
Endüstriyel Ethernet 4x2xAWG24/1 PVC	standart - sabit	Kat6	805655	CMG	1,0 mm	8,0 mm
Endüstriyel Ethernet 4x2xAWG24/1 PVC	standart - sabit		805681	AWM 30V	1,0 mm	8,0 mm
Endüstriyel Ethernet 4x2xAWG24/7 PVC	hareketli kablo kanalı		805658	CMG	1,1 mm	8,0 mm
Endüstriyel Ethernet 4x2xAWG26/7 PUR	hareketli kablo kanalı		803387	CMX	1,0 mm	7,8 mm
Endüstriyel Ethernet 4x2xAWG24/1 PVC	standart - sabit	Kat6 _A	803693	CMG	1,5 mm	9,6 mm
Endüstriyel Ethernet 4x2xAWG24/7 PVC	hareketli kablo kanalı		805704	CM	1,3 mm	8,9 mm
Endüstriyel Ethernet 4x2xAWG24/7 PUR	hareketli kablo kanalı		805703	CMX	1,3 mm	8,9 mm
Endüstriyel Ethernet 4x2xAWG26/7 PUR	hareketli kablo kanalı		805548	CMX	1,0 mm	7,8 mm
Endüstriyel Ethernet 4x2xAWG26/7 PUR	sağlam - esnek	Kat7	802184	AWM 30V	1,0 mm	6,4 mm
Endüstriyel Ethernet 4x2xAWG24/7 FRNC	gemi yapımı - esnek		803382	GL DNV	1,4 mm	9,1 mm
Endüstriyel Ethernet 4x2xAWG24/7 PUR	hareketli kablo kanalı		805614	CMX AWM 600V	1,3 mm	8,7 mm
Endüstriyel Ethernet 4x2xAWG24/7 PUR	Robotik		805828	CMX AWM 600V	1,3 mm	8,7 mm
Endüstriyel Ethernet 4x2xAWG23/1 PUR	sağlam - sabit	Kat7 _A	805680	mevcut değil	1,4 mm	7,8 mm
Endüstriyel Ethernet 4x2xAWG26/7 PUR	sağlam - esnek		805684	AWM 30V	1,0 mm	6,2 mm
Endüstriyel Ethernet 4x2xAWG23/1 PUR	sağlam - esnek	Kat7e	801197	mevcut değil	1,3 mm	7,8 mm
CC-Link IE 4x2xAWG24/1 PVC	standart - sabit	Kat5	81610	mevcut değil	1,0 mm	6,0 mm
CC-Link IE 4x2xAWG22/1 PVC	standart - sabit	Kat6 _A	803693	CMG	1,5 mm	9,6 mm
CC-Link IE 4x2xAWG23/1 FRNC	halojensiz - sabit	Kat7e	80810	mevcut değil	1,3 mm	7,5 mm
CC-Link IE 4x2xAWG23/1 PUR	sağlam - sabit		801197	mevcut değil	1,3 mm	7,8 mm
CC-Link IE 4x2xAWG24/7 PUR	hareketli kablo kanalı	Kat7	805614	CMX	1,3 mm	8,7 mm

RJ45 KONNEKTÖRLER

Kategori	Konnektör	Pinler	Ürün No.	Damar Ø	Kablo Ø	AWG-Tel	AWG-Çok telli iletken	UL	Sınıf	standart
Kat5	düz	4	800986	maks. 1,6mm	6,1-6,9 mm	22-23	22-24/7	-	IP20	Profinet
	düz	4	803841		4,5-8,0 mm	22-26	22-26/7	-		Profinet
	düz	8	802920		4,5-8,0 mm	22-26/7		Evet		
	90° açılı	8	804234		4,5-8,0 mm	23-26	26-23/7	Evet		
	düz-metal	4	805401		6,3-6,7 mm	22-24		-		Profinet
	90° açılı - metal	4	805402		6,3-6,7 mm	22-24		-		Profinet
	düz	4	805781		4,5-9,0 mm	22-24	22-27	-		Profinet
	45° açılı	4	805782		4,5-8,0 mm	22-24	22-27	-		Profinet
Kat6E _A	düz	8	801318	-	5,0-8,5 mm	24	24-26	-	IP67	
	düz	8	805783	maks. 1,6mm	4,5-9,0 mm	22-24	22-27	-	IP20	
Kat6 _A	45° açılı	8	805784		4,5-8,0 mm	22-24	22-27	-		
Kat6 _A	düz- metal	8	804544	-	5,0-9,5 mm	22-26	22-27/7	-		



M12 KONNEKTÖRLER

Kategori	Konnektör	Pinler	Ürün No.	Damar Ø	Kablo Ø	AWG-Tel	AWG-Çok telli iletken	UL	Sınıf	standart
Kat5 D-kodlu	düz - metal	4	803894	maks. 1,6 mm	4,0-8,0 mm		22-26	-	IP67	
	90° açılı - metal	4	805958				22-26	-		
	düz - metal	4	805966				22-26	-		PROFINet
	düz - metal	4	806205	maks. 2 mm	5,0-9,7 mm	20-24	-	PROFINet		
	90° açılı - metal	4	805967	maks. 1,6 mm	4,0-8,0 mm	22-26	-	PROFINet		
Kat6 _A X kodlu	düz - metal	8	805959	-	4,0-8,0 mm	26	26	Evet		
	düz - metal	8	806206	maks. 2 mm	5,0-9,7 mm	22-26	22-26	-		
	90° açılı - metal	8	805960	-	4,0-8,0 mm	26	26	Evet		



ALETLER

Tip	Ürün No.	Tanımlama
PROFINet SK Sıyırma aleti	801497	Tek bir işlemde nominal 6,5 mm dış çaplı PROFINet™ kablo (A, B ve C) tiplerinin sıyırılması ve soyulması için kullanılır
ETHERNET Soyma aleti	82902	Ekranlı ve ekranlı veri kablolarını 0,5 - 12,5 mm arasında sıyırma için kullanılır. 4mm ² 'ye kadar kablo kesimi mümkündür.

Diğer aletleri ve çantaları "Veri, Ağ ve Bus Teknolojisi" kataloğumuzda, 345. sayfadan itibaren bulabilirsiniz.



SONLANDIRILMIŞ KABLolar

PROFINET & ENDÜSTRİYEL ETHERNET & CC-LINK IE

Konnektör tarafı A	Talep üzeri kablo tipi ve uzunluk	Konnektör tarafı B
RJ45 veya M12	Profinet A	RJ45 veya M12
	Profinet B	
	Profinet C	
	Endüstriyel Ethernet sabit, esnek veya hareketli kablo kanalı / Burulma	
RJ45	CC-Link IE	RJ45

PATCH KABLO HELUKAT ENDÜSTRİYEL BAĞLANTI SİSTEMLERİ

Ürün No.	Kablo tipi	Konnektör	Kombinasyon	Uzunluk	Ürün No.	Kablo tipi	Konnektör	Kombinasyon	Uzunluk
806393	PROFINET A 2x2xAWG22/1 PVC kılıflı sabit kurulum için, UL CMG 75°C, PLTC veya AWM 21694 600V CSA FT4 (daha fazla teknik bilgiler için Ürün No. 800653 bkz.)	RJ45 IP20 4 Pinli	iki taraflı düz	0,5 m	806401	PROFINET B 2x2xAWG22/7 PVC kılıflı esnek kullanım için, UL CMG 75°C, PLTC veya AWM 21694 600V CSA FT4 (daha fazla teknik bilgiler için Ürün No. 800654 bkz.)	RJ45 IP20 4 Pinli	iki taraflı düz	0,5 m
806394				1,0 m	806402				1,0 m
806395			2,0 m	806403	2,0 m				
806396			3,0 m	806404	3,0 m				
806397			5,0 m	806405	5,0 m				
806398			10,0 m	806406	10,0 m				
806399			15,0 m	806407	15,0 m				
806400			25,0 m	806408	25,0 m				
806425			iki taraflı 90° açılı	0,5 m	806433			0,5 m	
806426				1,0 m	806434			1,0 m	
806427		2,0 m		806435	2,0 m				
806428		3,0 m		806436	3,0 m				
806429		5,0 m		806437	5,0 m				
806430		10,0 m	806438	10,0 m					
806431		15,0 m	806439	15,0 m					
806432		25,0 m	806440	25,0 m					
806457		M12 D-kodlu IP 67	iki taraflı düz	0,5 m	806465		M12 D-kodlu IP 67	iki taraflı düz	0,5 m
806458				1,0 m	806466				1,0 m
806459			2,0 m	806467	2,0 m				
806460			3,0 m	806468	3,0 m				
806461			5,0 m	806469	5,0 m				
806462			10,0 m	806470	10,0 m				
806463			15,0 m	806471	15,0 m				
806464			25,0 m	806472	25,0 m				
806489			iki taraflı 90° açılı	0,5 m	806497			0,5 m	
806490	1,0 m			806498	1,0 m				
806491	2,0 m	806499		2,0 m					
806492	3,0 m	806500		3,0 m					
806493	5,0 m	806501		5,0 m					
806494	10,0 m	806502	10,0 m						
806495	15,0 m	806503	15,0 m						
806496	25,0 m	806504	25,0 m						
806521	PROFINET B 2x2xAWG22/7 PVC kılıflı esnek kullanım için UL CMG 75°C, PLTC veya AWM 21694 600V CSA FT4 (daha fazla teknik bilgiler için Ürün No. 800654 bkz.)	RJ45 IP20 4 Pinli	iki taraflı düz	5,0 m	M12 D-kodlu IP67	iki taraflı düz	5,0 m		
806522				10,0 m			806523	10,0 m	
806523			20,0 m	806524		25,0 m			
806524			40,0 m	806525		50,0 m			
806525			60,0 m	806526		70,0 m			
806526		80,0 m	806527	90,0 m					
806528		100,0 m	806529						
806530			806531						



RJ45 - KONNEKTÖR IP20

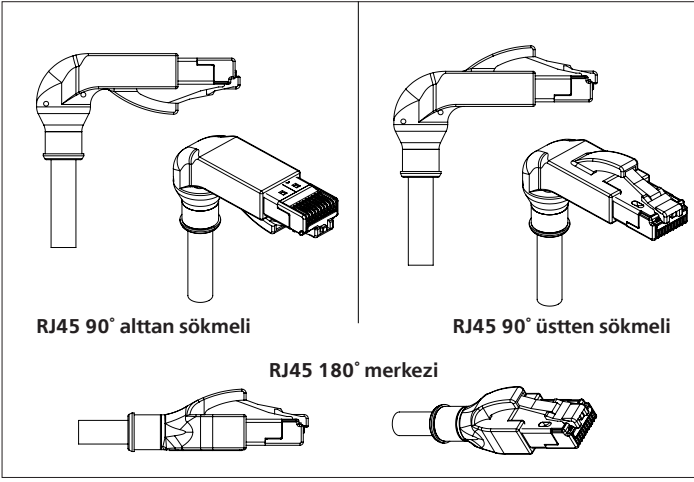

Kat5

90° Kablo çıkışı
Üstten sökmeli



Kat6_A

180° merkezi kablo çıkışı



Ürün No.	Kablo tipi	Konnektör	Kombinasyon	Uzunluk
806409	Profinet C 2x2xAWG22/7 PUR kılıflı hareketli kablo kanalı için, UL CMX 75 °C (daha fazla teknik bilgiler için Ürün No. 800655 bkz.)	RJ45 IP20 4 Pinli	iki taraflı düz	0,5 m
806410				1,0 m
806411				2,0 m
806412				3,0 m
806413				5,0 m
806414				10,0 m
806415			15,0 m	
806416			25,0 m	
806449			iki taraflı 90° açılı	0,5 m
806450				1,0 m
806451		2,0 m		
806452		3,0 m		
806453		5,0 m		
806454		10,0 m		
806455		15,0 m		
806456		25,0 m		
806481		M12 D-kodlu IP67	iki taraflı düz	0,5 m
806482				1,0 m
806483				2,0 m
806484				3,0 m
806485				5,0 m
806486				10,0 m
806487			15,0 m	
806488			25,0 m	
806505			iki taraflı 90° açılı	0,5 m
806506	1,0 m			
806507	2,0 m			
806508	3,0 m			
806509	5,0 m			
806510	10,0 m			
806511	15,0 m			
806512	25,0 m			

Ürün No.	Kablo tipi	Konnektör	Kombinasyon	Uzunluk
806417	PROFINet C 2x2xAWG22/7 PVC kılıflı hareketli kablo kanalı için, UL CMG 75°, PLTC veya AWM 600V CSA FT4 (daha fazla teknik bilgiler için Ürün No. 802194 bkz.)	RJ45 IP20 4 Pinli	iki taraflı düz	0,5 m
806418				1,0 m
806419				2,0 m
806420				3,0 m
806421				5,0 m
806422				10,0 m
806423			15,0 m	
806424			25,0 m	
806441			iki taraflı 90° açılı	0,5 m
806442				1,0 m
806443		2,0 m		
806444		3,0 m		
806445		5,0 m		
806446		10,0 m		
806447		15,0 m		
806448		25,0 m		
806473		M12 D-kodlu IP67	iki taraflı düz	0,5 m
806474				1,0 m
806475				2,0 m
806476				3,0 m
806477				5,0 m
806478				10,0 m
806479			15,0 m	
806480			25,0 m	
806513			iki taraflı 90° açılı	0,5 m
806514	1,0 m			
806515	2,0 m			
806516	3,0 m			
806517	5,0 m			
806518	10,0 m			
806519	15,0 m			
806520	25,0 m			
11007406	RJ45 IP20 4 Pinli	iki taraflı düz	0,5 m	
11007407			1,0 m	
11007408			2,0 m	
11007409			3,0 m	
11007410			5,0 m	
11007411			10,0 m	
11007412		15,0 m		
11007413		25,0 m		
		M12 D-kodlu IP67	iki taraflı düz	0,5 m
				1,0 m
	2,0 m			
	3,0 m			



M12 - KONNEKTÖR IP67

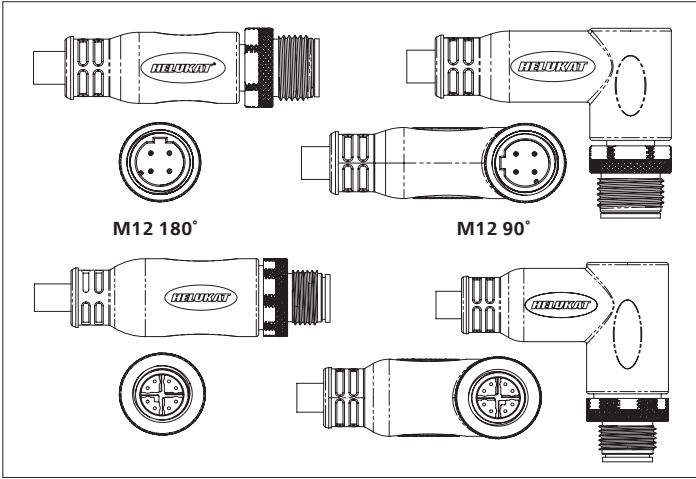











D-kodlu Kat5 90° Kablo çıkışı



X-kodlu Kat6A 90° Kablo çıkışı



Ürün No.	Kablo tipi*	Konnektör	Kombinasyon	Uzunluk
806546	Endüstriyel Ethernet HELUKAT100S SF/UTP Kat5e 4x2xAWG26/19 PUR kılıflı hareketli kablo kanalı için, UL AWM (daha fazla teknik bilgiler için Ürün No. 82839 bkz.)	RJ45 IP20 8 Pinli	iki taraflı düz	0,5 m
806547				1,0 m
806548				2,0 m
806549				3,0 m
806550				5,0 m
806551				10,0 m
806552				15,0 m
806553				20,0 m
806554				25,0 m
806555				iki taraflı 90° açılı
806556			1,0 m	
806557			2,0 m	
806558			3,0 m	
806559			5,0 m	
806560			10,0 m	
806561			15,0 m	
806562			20,0 m	
806563			25,0 m	
806564			iki taraflı düz	0,5 m
806565			1,0 m	
806566			2,0 m	
806567			3,0 m	
806568			5,0 m	
806569			10,0 m	
806570			15,0 m	
806571		20,0 m		
806572		25,0 m		
806573		iki taraflı 90° açılı	0,5 m	
806574		1,0 m		
806575		2,0 m		
806576		3,0 m		
806577		5,0 m		
806578		10,0 m		
806579		15,0 m		
806580		20,0 m		
806581		25,0 m		

Ürün No.	Kablo tipi*	Konnektör	Kombinasyon	Uzunluk
806532	Endüstriyel Ethernet HELUKAT200 IND SF/ UTP Kat5e 4x2xA- WG26/7 PUR kılıflı esnek kullanım için (daha fazla teknik bilgiler için Ürün No. 800068 bkz.)	RJ45 IP20 8 Pinli	iki taraflı düz	0,5 m
806533				1,0 m
806534				2,0 m
806535				3,0 m
806536				5,0 m
806537			10,0 m	
806538			15,0 m	
806539			iki taraflı düz	0,5 m
806540			1,0 m	
806541			2,0 m	
806542		3,0 m		
806543		5,0 m		
806544		10,0 m		
806545		15,0 m		

* M12 D-kodlu sadece 4 pinli

* M12 D-kodlu sadece 4 pinli



M12 - SOKET IP67

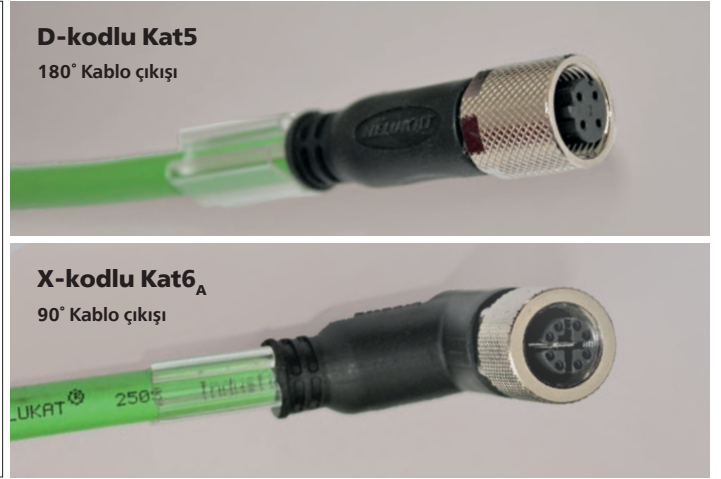
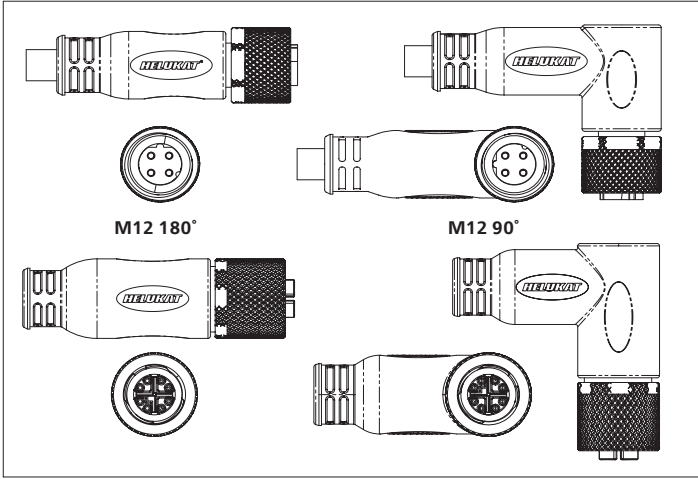

Ürün No.	Kablo tipi	Konnektör	Kombinasyon	Uzunluk
806582	Endüstriyel Ethernet HELUKAT500S SF/FTP Kat6 _A 4x2xAWG26/7 PUR kılıflı hareketli kablo kanalı için, UL CMX 75° (daha fazla teknik bilgiler için Ürün No. 805548 bkz.)	RJ45 IP20 8 Pinli	iki taraflı düz	0,5 m
806583				1,0 m
806584			2,0 m	
806585			3,0 m	
806586			5,0 m	
806587			10,0 m	
806588			15,0 m	
806589			20,0 m	
806590			25,0 m	
806591			iki taraflı 90° açılı	0,5 m
806592		1,0 m		
806593		2,0 m		
806594		3,0 m		
806595		5,0 m		
806596		10,0 m		
806597		15,0 m		
806598		20,0 m		
806599		25,0 m		
806600		M12 X-kodlu IP67	iki taraflı düz	0,5 m
806601				1,0 m
806602			2,0 m	
806603			3,0 m	
806604			5,0 m	
806605			10,0 m	
806606			15,0 m	
806607	20,0 m			
806608	25,0 m			
806609	iki taraflı 90° açılı		0,5 m	
806610			1,0 m	
806611			2,0 m	
806612			3,0 m	
806613			5,0 m	
806614			10,0 m	
806615			15,0 m	
806616	20,0 m			
806617	25,0 m			

Ürün No.	Kablo tipi	Konnektör	Kombinasyon	Uzunluk
806618	Endüstriyel Ethernet HELUKAT600IND S/FTP Kat6 _A 4x2xAWG26/7 PUR kılıflı esnek kullanım için, UL AWM (daha fazla teknik bilgiler için Ürün No. 802184 bkz.)	RJ45 IP20 8 Pinli	iki taraflı düz	0,5 m
806619				1,0 m
806620			2,0 m	
806621			3,0 m	
806622			5,0 m	
806623			10,0 m	
806624			15,0 m	
806625			20,0 m	
806626			25,0 m	
806627			iki taraflı 90° açılı	0,5 m
806628		1,0 m		
806629		2,0 m		
806630		3,0 m		
806631		5,0 m		
806632		10,0 m		
806633		15,0 m		
806634		20,0 m		
806635		25,0 m		
806636		M12 X-kodlu IP67	iki taraflı düz	0,5 m
806637				1,0 m
806638			2,0 m	
806639			3,0 m	
806640			5,0 m	
806641			10,0 m	
806642			15,0 m	
806643	20,0 m			
806644	25,0 m			
806645	iki taraflı 90° açılı		0,5 m	
806646			1,0 m	
806647			2,0 m	
806648			3,0 m	
806649			5,0 m	
806650			10,0 m	
806651			15,0 m	
806652	20,0 m			
806653	25,0 m			





HELUKABEL®

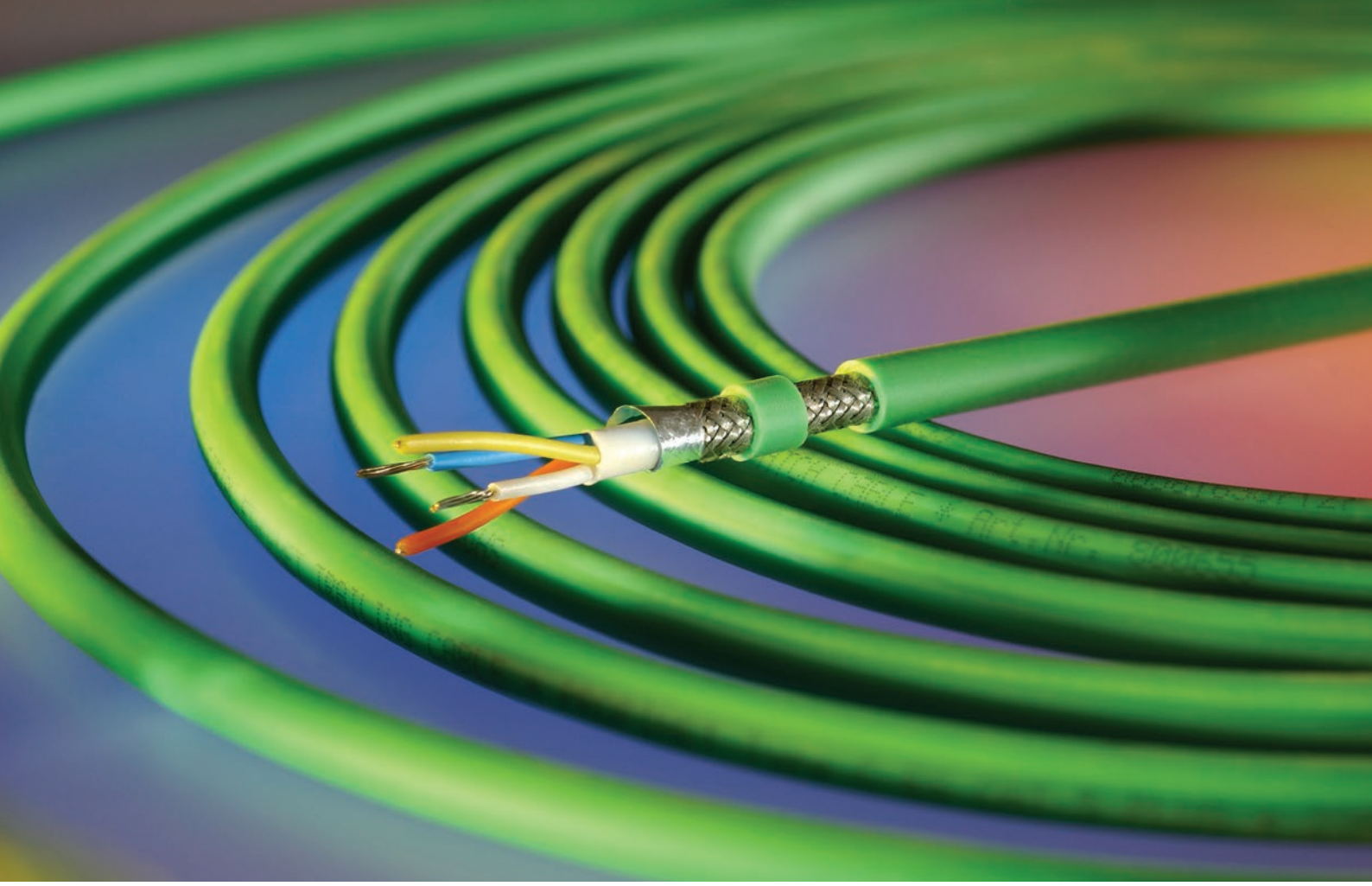

■ BİZİ NEREDE BULABİLİRSİNİZ?



HELUKABEL® GmbH
Dieselstr. 8-12
71282 Hemmingen
Almanya
Telefon: +49 7150 9209-0
info@helukabel.de



HELUKABEL® Kablo San.ve Tic.Ltd.Sti
Yakuplu Merkez Mah. Hürriyet Bulvarı, 228,
Sokak No:24 34524 İstanbul
Türkiye
Telefon: +90 212 502 41 95
info@helukabel.com.tr



HELUKABEL® ABD
Telefon: +1 847 930 5118
sales@helukabel.com



HELUKABEL® Avusturya
Telefon: +43 7224 90555 0
office@helukabel.at



HELUKABEL® Belçika
Telefon: +32 24 81 00 20
info@helukabel.be



HELUKABEL® Birleşik Arap Emirlikleri
Telefon: +971 48 87 95 94
info@helukabel.ae



HELUKABEL® Birleşik Krallık
Telefon: +44 151 345 0808
info@helukabel.co.uk



HELUKABEL® Brezilya
Telefon: +55 (19) 3514-4370
info@helukabel.com.br



HELUKABEL® Bulgaristan
Telefon: +359 888189638
info@helukabel.bg



HELUKABEL® Çek Cumhuriyeti
Telefon: +42 0312 672 620
prodej@helukabel.cz



HELUKABEL® Çin
Telefon: +86 21 58693999
info@helukabel.com.cn



HELUKABEL® Danimarka
Telefon: +45 24241044
kim.hansen@helukabel.dk



HELUKABEL® Endonezya
Telefon: +62 213 848872
sales@helukabel.co.id



HELUKABEL® Finlanda/CableX Oy
Telefon: +358 8800 020
cablex@cablex.fi



HELUKABEL® Fransa
Telefon: +33 389 627562
info@helukabel.fr



HELUKABEL® Güney Afrika
Telefon: +27 11 462 8752
info@helukabel.co.za



HELUKABEL® Güney Kore
Telefon: +82 51 9728646
info@helukabel.co.kr



HELUKABEL® Hindistan
Telefon: +91 22 25 18 58 41
info@helukabel.in



HELUKABEL® Hollanda
Telefon: +31 495 499 049
info@helukabel.nl



HELUKABEL® İspanya/Urkunde
Telefon: +34 943744264
urkunde@urkunde.es



HELUKABEL® İsveç
Telefon: +46 8 55 77 4280
info@helukabel.se



HELUKABEL® İsviçre
Telefon: +41 56 4181515
contact@helukabel.ch



HELUKABEL® İtalya
Telefon: +39 039 6081503
info@helukabel.it



HELUKABEL® Kanada
Telefon: +1 289 444 5040
sales@helukabel.ca



HELUKABEL® Malezya
Telefon: +603 7885 8724
sales@helukabel.com.my



HELUKABEL® Meksika
Telefon: +52 442 209 6400
info@helukabel.mx



HELUKABEL® Polonya
Telefon: +48 46 85 80 10 0
biuro@helukabel.pl



HELUKABEL® Portekiz
Telefon: +351 239 099596
geral@helukabel.pt



HELUKABEL® Romanya
Telefon: +40 310699085
office@helukabel.ro



HELUKABEL® Rusya
Telefon: +7 812 449 10 60
info@helukabel.ru



HELUKABEL® Singapur
Telefon: +65 65 54 6170
sales@helukabel.com.sg



HELUKABEL® Tayland
Telefon: +66 2927 3570 3
info@helukabel.co.th



HELUKABEL® Vietnam
Telefon: +84 8 38443698
info@helukabel.com.vn

helukabel.com.tr